

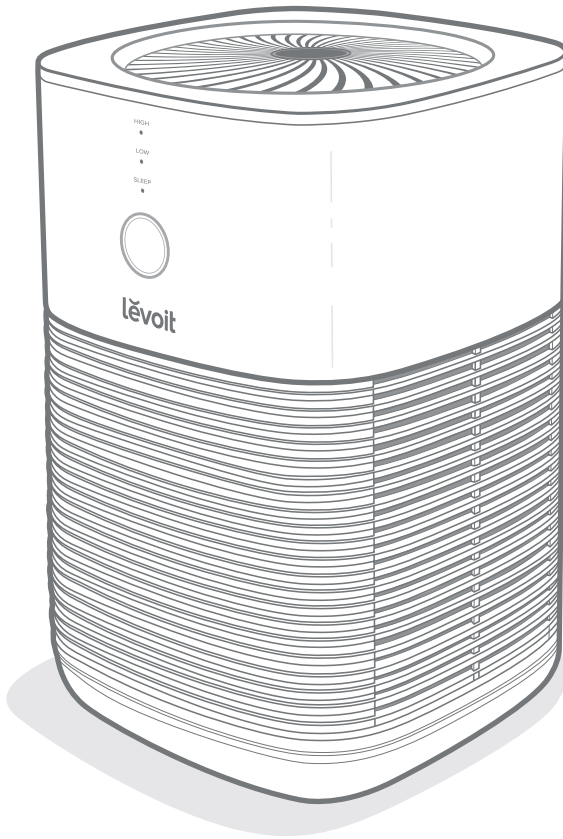

USER MANUAL

Desktop True HEPA Air Purifier

Models: LV-H128, LV-H128-RXA, LV-H128-RXB



Questions or Concerns?

Please contact us Mon–Fri, 9:00 am–5:00 pm PST/PDT at support@levoit.com or at **(888) 726-8520**.

Table of Contents

Package Contents	2
Specifications	2
Safety Information	3
Getting to Know Your Air Purifier	5
Getting Started	6
Using Your Air Purifier	7
Care & Maintenance	9
Troubleshooting	12
Warranty Information	15
Customer Support	16

Package Contents (1-Pack)

- 1 x Desktop True HEPA Air Purifier
- 2 x True HEPA Combination Filters (Pre-Installed)
- 1 x Aroma Pad
- 1 x AC Power Adapter
- 1 x User Manual

Package Contents (2-Pack)

- 2 x Desktop True HEPA Air Purifier
- 4 x True HEPA Combination Filters (Pre-Installed)
- 2 x Aroma Pad
- 2 x AC Power Adapter
- 1 x User Manual

Specifications

Rated Power	10W
Ideal Room Size	161 ft ² / 15 m ² Note: Effective for larger rooms, but purification will take longer.
Operating Conditions	Temperature: 14°–104°F / -10°–40°C
	Humidity: ≤ 85% RH
Noise Level	28–44dB
Air Purifier Dimensions	6.7 x 6.7 x 10.4 in / 17 x 17 x 26.5 cm
Air Purifier Weight	3.3 lb / 1.5 kg
Power Adapter	Input: 100–240V~ 50/60Hz
	Output: 12V=1A

READ AND SAVE THESE INSTRUCTIONS

SAFETY INFORMATION

To reduce the risk of fire, electric shock, or other injury, follow all instructions and safety guidelines.

General Safety

- **Only** use your air purifier as described in this manual.
- **Do not** use without removing the plastic wrap from the filter. The air purifier will not filter air, and may overheat, causing a fire hazard.
- **Do not** use your air purifier outdoors.
- Keep your air purifier away from water, and wet or damp areas. **Never** place in water or other liquids.
- **Do not** use in excessively humid areas.
- Keep the inside of the air purifier dry. To prevent moisture buildup, avoid placing in rooms with major temperature changes or underneath air conditioners.
- Keep your air purifier away from heat sources.
- **Do not** use where combustible gases, vapours, metallic dust, aerosol (spray) products, or fumes from industrial oil are present.
- Keep 5 ft / 1.5 m away from where oxygen is being administered.
- Supervise children when they are near the air purifier.
- **Do not** place anything into any opening on the air purifier, unless directed by the manual.
- **Do not** sit or place heavy objects on the air purifier.
- **Always** unplug your air purifier before servicing (such as changing filters).
- **Do not** add essential oils to the filters. The filters will be damaged by the oil and will eventually release an unpleasant smell. **Only** add essential oils (not included) to the aroma box at the top of the air purifier.
- **Do not** use your air purifier if it is damaged or not working correctly, or if the cord or plug is damaged. **Do not** try to repair it yourself. Contact **Customer Support** (see page 16).
- **WARNING:** To reduce the risk of fire or electric shock, **do not** use this air purifier with any solid-state speed controls (such as a dimmer switch).
- Not for commercial use. Household use **only**.

SAFETY INFORMATION (CONT.)

Power Adapter & Cord

- Keep air purifier near the outlet it is plugged into.
- **Never** place the cord near any heat source.
- **Do not** cover the cord with a rug, carpet, or other covering. **Do not** place the cord under furniture or appliances.
- Keep the cord out of areas where people walk often. Place the cord where it will not be tripped over.

Electromagnetic Fields (EMF)

Your Levoit air purifier complies with all standards regarding electromagnetic fields (EMF). If handled properly and according to the instructions in this user manual, the appliance is safe to use based on scientific evidence available today.

GETTING TO KNOW YOUR AIR PURIFIER

- A. Fan Speed Indicators
- B. Control Button
- C. Indicator Ring
- D. Air Outlet
- E. Housing
- F. AC Power Adapter Input
- G. True HEPA Combination Filters
- H. Filter Cover Lock
- I. Anti-Skid Pads
- J. Filter Cover
- K. Air Inlets
- L. AC Power Adapter
- M. Aroma Box
- N. Aroma Pad Cap
- O. Aroma Pad

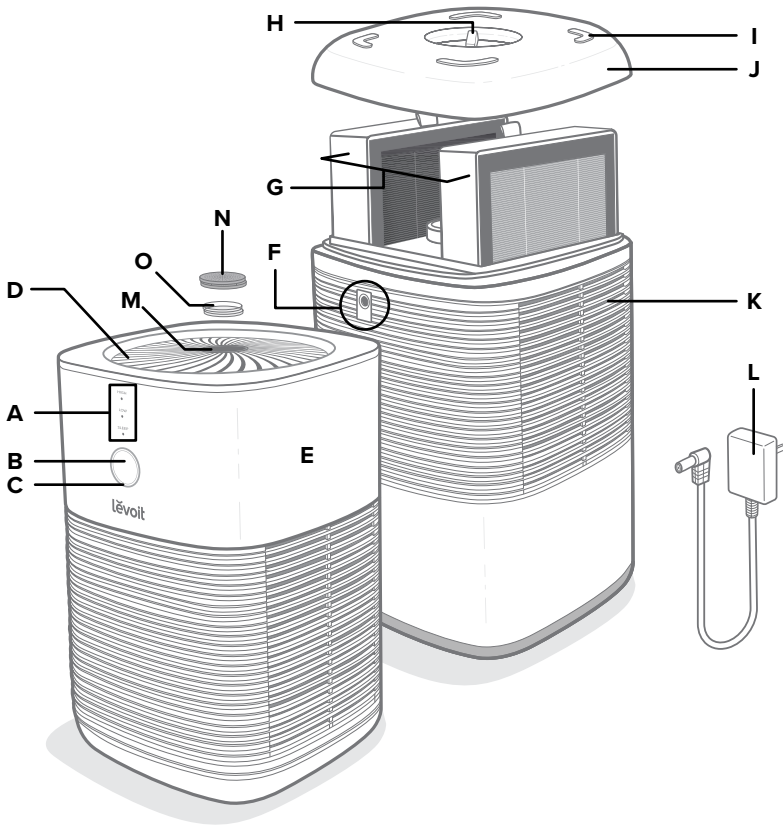

Note: The Indicator Ring lights up white when the air purifier is turned on, and lights up red to remind you to check your filters (see **Check Filter Indicator Light**, page 9).

GETTING TO KNOW YOUR AIR PURIFIER (CONT.)

About the Filters

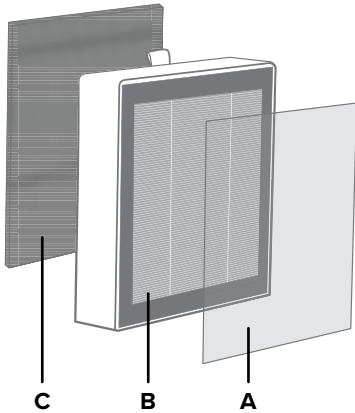

Your Levoit Desktop True HEPA Air Purifier uses 2 filters, both of which use a 3-stage air filtration system to purify air.

A. Fine Preliminary Filter (Pre-Filter)

- Captures large particles such as dust, lint, fibers, hair, and pet fur.
- Maximizes the life of the True HEPA Filter by protecting it.

B. H13 True HEPA Filter

- Captures at least 99.97% of airborne particles 0.3 microns (μm) in size.
- Filters small particles such as fine dust, smoke particles, and allergens such as pollen and pet dander.

C. Activated Carbon Filter

- Physically adsorbs smoke, odors, and fumes.

GETTING STARTED

1. Flip over the air purifier. Twist the cover lock clockwise and lift the filter cover off of the air purifier. **[Figure 1.1]**
2. Take out the filters and remove the filters from their plastic packaging. **[Figure 1.2]**

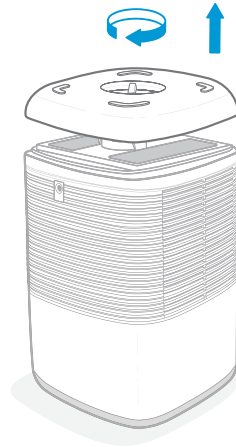

Figure 1.1

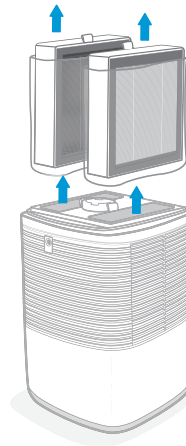

Figure 1.2

Note: Levoit air purifiers filter airborne particles 0.3 microns in size. Arovast Corporation makes no claims that this air purifier helps reduce the COVID-19 virus.

GETTING STARTED (CONT.)

- Place the filters back into the air purifier. The Pre-Filter must be facing outward and the Activated Carbon Filter must be facing inward for both filters. Make sure the pull tabs are visible and facing inward. **[Figure 1.3]**
- Replace the filter cover. Twist the cover lock counter-clockwise to secure the cover.
- Place your air purifier on a flat, stable surface with the air outlet facing up. Leave 15 inches / 38 cm of clearance on all sides of the air purifier.
- Connect the AC power adapter to the air purifier. Plug into an outlet.

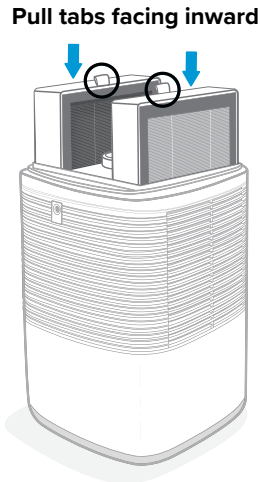

Figure 1.3

USING YOUR AIR PURIFIER

WARNING: Make sure the air outlet and the air inlets are not blocked. This may cause the air purifier to overheat and stop working.

- Press the Control Button to turn on the air purifier. The fan will start on "SLEEP".

Note:

- Sleep Mode uses the lowest possible fan speed for a quiet environment.*
- In Sleep Mode, the display lights will automatically turn off after 5 seconds. Press the Control Button again to turn the display lights back on for 5 seconds.*

- Optionally, press the Control Button repeatedly to change fan speed ("SLEEP", "LOW", and "HIGH"), and to turn the air purifier off.

Note:

- "HIGH" is the loudest fan speed, but cleans air the quickest.*
- For best results, or to address a specific air quality issue such as smoke, run the air purifier on "HIGH" for 15–20 minutes before using a lower speed.*
- To effectively clean air, keep windows and doors closed while the air purifier is on.*

USING YOUR AIR PURIFIER (CONT.)

Essential Oils

Do not add essential oils to the filters or the fan. The filters will be damaged by the oil and will eventually release an unpleasant smell. **Only** add essential oils to the aroma box at the top of the air purifier.

***Note:** Essential oils are not included.*

Adding Essential Oils

1. Remove the aroma box cap.
2. Add 2–3 drops of the essential oil to the aroma pad.
3. Replace the cap.

***Note:** Do not mix essential oil blends. Clean the aroma pad before using a new essential oil blend (see **Cleaning the Aroma Pad**, page 10).*

Clean Air Delivery Rate

This air purifier has a Clean Air Delivery Rate of 75 cubic meters per hour.

Clean Air Delivery Rate (CADR) measures the efficiency of an air purifier by indicating the volume of clean air that an air purifier produces. This is based on the removal of dust, pollen, and smoke, which are the 3 most common indoor air pollutants. The higher the CADR, the more particles the air purifier will remove and the larger the area it can clean. The rating is measured at the air purifier's highest speed.

Air Purifier Placement

For highest efficiency of air purification, make sure that airflow isn't obstructed. To allow air to circulate freely in and out of the air purifier, there should ideally be 15 inches / 38 cm of clearance on all sides of the air purifier. Avoid placing too near a corner or too close to a wall. Keep away from curtains and anything that might block airflow.

Humidity

Moisture may damage the filters. This air purifier should be used in an area with a humidity level below 85% RH. If you use the air purifier in excessively humid areas, the surface of the filters will become moldy.

***Note:** Water or moisture will allow mold to grow. To solve a mold problem, get rid of the source of the moisture and clean up the mold.*

CARE & MAINTENANCE

Cleaning the Air Purifier

Note:

- For best performance, clean every 1–2 months.
 - **WARNING: Do not disassemble the air purifier, such as by removing any screws. Only remove the filter cover and replace filters as directed.**
 - **Do not clean with detergents or soap, as this may cause damage or discoloration. Do not clean with abrasive chemicals or flammable cleaning agents.**
1. Unplug before cleaning.
 2. Wipe the outside of the air purifier with a soft, dry cloth. If necessary, also wipe with a damp cloth, then immediately dry.
 3. Vacuum the inside of the air purifier using a vacuum hose with a crevice attachment. **[Figure 2.1]**

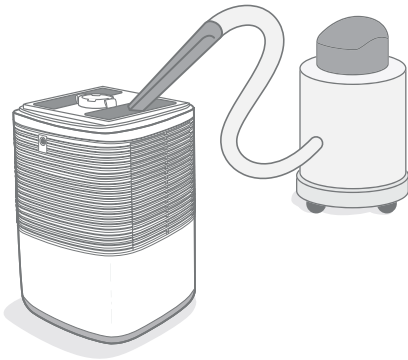

Figure 2.1

Cleaning the Filters

The Pre-Filters should be cleaned about once a month to increase the efficiency and extend the life of your filters. Clean the outside of the Pre-Filter using a soft brush or a vacuum hose with a soft brush attachment to remove hair, dust, and large particles. **Do not** clean any part of the filters with water or other liquids.

Filter	When to Clean	When to Replace
Pre-Filters	Every 2–4 weeks	6–8 months
True HEPA & Activated Carbon Filters	Do not clean	

Check Filter Indicator Light

The Control Button will light up red as a reminder to check the filters. Depending on how often you use the air purifier, the indicator should turn on within 6–8 months. You may not need to replace your filters yet, but you should check them when the Control Button lights up red.

CARE & MAINTENANCE (CONT.)

Resetting the Check Filter Indicator

Reset the indicator light when:

- A. The Control Button lights up red.
 - 1. Replace the filters (see **Replacing the Filters**, page 11).
 - 2. With the air purifier plugged in and the fan turned off, press and hold the Control Button for 3 seconds.
 - 3. The red light will turn off when successfully reset.
- B. The filters were changed before the Control Button lit up red.
 - 3. With the air purifier plugged in and the fan turned off, press and hold the Control Button for 3 seconds. This will turn on the red indicator light.
 - 4. Press and hold the Control Button again for 3 seconds.
 - 5. The red light will turn off when successfully reset.

Note: You cannot reset the indicator light if the fan is on at any speed.

Cleaning the Aroma Pad

For effective aromatherapy, the aroma pad should always be cleaned before using a new essential oil blend. **Do not** mix essential oil blends.

To clean:

- 1. Remove the aroma box cap.
- 2. Remove the aroma pad and rinse under warm, running water.
- 3. Dry with a clean cloth and place it back into the aroma box.

Note: *Do not* pour liquid cleaners or detergents into the aroma pad or box.

Replacing the Aroma Pad

If the aroma pad becomes deformed or damaged after repeated washing, it may need to be replaced. Replacement aroma pads can be purchased at **levoit.com**.

CARE & MAINTENANCE (CONT.)

When Should I Replace the Filters?

You should replace your filters every 6–8 months. You may need to change your filters sooner or later depending on how often you use your air purifier. Using your air purifier in an environment with relatively high pollution may mean you will need to change the filters more often, even if the red indicator light is off.

You may need to replace your filters if you notice:

- Increased noise when the air purifier is on
- Decreased airflow
- Unusual odors
- Visibly clogged filters

Note: To maintain the performance of your air purifier, **only** use official Levoit filters. To buy replacement filters, visit Levoit's online store. Go to [levoit.com](https://www.levoit.com) for more information.

Replacing the Filters

1. Unplug the air purifier. Flip the air purifier over and remove the filter cover (see **Getting Started**, page 6).
2. Remove the old filters.
3. Clean out any remaining dust or hair inside the air purifier using a vacuum hose with a crevice attachment. **Do not** use water or liquids to clean the air purifier.
4. Unwrap the new filters and place them into the air purifier (see **Getting Started**, page 6).
5. Replace the cover. Plug in the air purifier.
6. Reset the Check Filter Indicator light (see **Resetting the Check Filter Indicator Light**, page 10).

Storage

If not using the air purifier for an extended period of time, wrap the filters in plastic packaging and store in a dry place to avoid moisture damage.

TROUBLESHOOTING

Problem	Possible Solution
Air purifier will not turn on or respond to button controls.	Plug in the air purifier.
	Plug the air purifier into a different outlet.
	Disconnect the AC power adapter from the air purifier and reconnect it.
	Check to see if the AC power adapter is damaged. If so, stop using the air purifier and contact Customer Support (see page 16).
	The air purifier may be malfunctioning. Contact Customer Support (see page 16).
Airflow is significantly reduced.	Make sure the filters are removed from their packaging and properly in place (see Getting Started , page 6).
	Press the Control Button to increase fan speed.
	Leave at least 15 inches / 38 cm of clearance on all sides of the air purifier.
	The Pre-Filters may be clogged by large particles, such as hair or lint, blocking airflow. Clean the Pre-Filters (see Cleaning the Filters , page 9).
	Replace the filters (see Replacing the Filters , page 11).
Air purifier makes an unusual noise while the fan is on.	Make sure the filters are properly in place with plastic packaging removed (see Getting Started , page 6).
	Make sure the air purifier is operating on a hard, flat, level surface.
	Replace the filters (see Replacing the Filters , page 11).
	The air purifier may be damaged, or a foreign object may be inside. Stop using the air purifier and contact Customer Support (see page 16). Do not try to repair the air purifier.
Poor air purification quality.	Press the Control Button to increase fan speed.
	Make sure no objects are blocking the sides or top of the air purifier (the outlet or inlets).
	Make sure the filters are removed from its packaging and properly in place (see Getting Started , page 6).
	Close doors and windows while using the air purifier.
	If the room is larger than 161 ft ² / 15 m ² , air purification will take longer. The air purifier may not be as effective in significantly larger rooms.
	Replace the filters (see Replacing the Filters , page 11).

TROUBLESHOOTING (CONT.)

Problem	Possible Solution
Strange smell coming from the air purifier.	Clean the filters and aroma pad or replace if necessary.
	Contact Customer Support (see page 16).
	Avoid using your air purifier in an area with high humidity.
The Check Filter Indicator light is still on after replacing the filters.	Reset the Check Filter Indicator (see Resetting the Check Filter Indicator Light , page 10).
The Check Filter Indicator light has not turned on within 8 months.	The Check Filter Indicator light is a reminder for you to check the filters and will light up based on how long the air purifier has been used (see When Should I Replace the Filters? , page 11). If you don't use your air purifier often, the Check Filter Indicator light will take longer to turn on.
The Check Filter Indicator light turned on before 6 months.	The Check Filter Indicator light is a reminder for you to check the filters and will light up based on how long the air purifier has been used (see When Should I Replace the Filters? , page 11). If you run your air purifier frequently, the Check Filter Indicator light will turn on sooner.

If your problem is not listed, please contact **Customer Support** (see page 16).

FEDERAL COMMUNICATION COMMISSION INTERFERENCE STATEMENT

NOTE: This equipment has been tested and found to comply with the limits for a Class B digital device, pursuant to part 15 of the FCC Rules. These limits are designed to provide reasonable protection against harmful interference in a residential installation. This equipment generates, uses and can radiate radio frequency energy and, if not installed and used in accordance with the instructions, may cause harmful interference to radio communications. However, there is no guarantee that interference will not occur in a particular installation. If this equipment does cause harmful interference to radio or television reception, which can be determined by turning the equipment off and on, the user is encouraged to try to correct the interference by one or more of the following measures:

- Reorient or relocate the receiving antenna.
- Increase the separation between the equipment and receiver.
- Connect the equipment into an outlet on a circuit different from that to which the receiver is connected.
- Consult the dealer or an experienced radio/TV technician for help.

FCC Caution: Any changes or modifications not expressly approved by the party responsible for compliance could void the user's authority to operate this equipment.

This device complies with part 15 of the FCC Rules. Operation is subject to the following two conditions:

1. This device may not cause harmful interference, and
2. This device must accept any interference received, including interference that may cause undesired operation.

WARRANTY INFORMATION

Product Name	Desktop True HEPA Air Purifier
Models	LV-H128, LV-H128-RXA, LV-H128-RXB
<i>For your own reference, we strongly recommend that you record your order ID and date of purchase.</i>	
Date of Purchase	
Order ID	

Terms & Policy

Arovast Corporation (“Arovast”) warrants this product to the original purchaser to be free from defects in material and workmanship, under normal use and conditions, for a period of 1 year from the date of original purchase.

Arovast agrees, at our option during the warranty period, to repair any defect in material or workmanship or furnish an equal product in exchange without charge, subject to verification of the defect or malfunction and proof of the date of purchase.

There is no other express warranty. This warranty does not apply:

- If the product has been modified from its original condition;
- If the product has not been used in accordance with directions and instructions in the user manual;
- To damages or defects caused by accident, abuse, misuse or improper or inadequate maintenance;
- To damages or defects caused by service or repair of the product performed by an unauthorized service provider or by anyone other than Arovast;
- To damages or defects occurring during commercial use, rental use, or any use for which the product is not intended;
- To damages or defects exceeding the cost of the product.

Arovast will not be liable for indirect, incidental, or consequential damages in connection with the use of the product covered by this warranty.

This warranty extends only to the original consumer purchaser of the product and is not transferable to any subsequent owner of the product regardless of whether the product is transferred during the specified term of the warranty.

This warranty does not extend to products purchased from unauthorized sellers. Arovast’s warranty extends only to products purchased from authorized sellers that are subject to Arovast’s quality controls and have agreed to follow its quality controls.

All implied warranties are limited to the period of this limited warranty.

This warranty gives you specific legal rights and you may also have other rights which vary from state to state. Some states do not allow the exclusion or limitation of incidental or consequential damages, so the above limitation or exclusion may not apply to you.

If you discover that your product is defective within the specified warranty period, please contact Customer Support via support@levoit.com. **DO NOT** dispose of your product before contacting us. Once our Customer Support Team has approved your request, please return the product with a copy of the invoice and order ID.

Extend Your Warranty by 1 Year

Register your product within 14 days of purchase at www.levoit.com/warranty to extend your 1-year warranty by an additional year.

This warranty is made by:

Arovast Corporation
1202 N. Miller St., Suite A
Anaheim, CA 92806

CUSTOMER SUPPORT

If you have any questions or concerns about your new product, please contact our helpful Customer Support Team.

Customer Support

Distributed by Arovast Corporation

1202 N. Miller St., Suite A
Anaheim, CA 92806

Email: support@levoit.com

Toll-Free: (888) 726-8520

Support Hours

Mon–Fri, 9:00 am–5:00 pm PST/PDT

*Please have your order invoice and order ID ready before contacting Customer Support.

lėvoit[®]

levoit.com

Connect with us @LevoitLifestyle

