

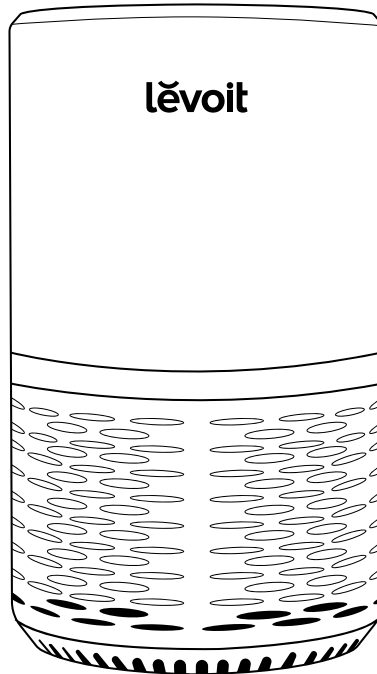

USER MANUAL

Personal True HEPA Air Purifier

Models: LV-H132, LV-H132XR



Questions or Concerns?

Please contact us Mon-Fri, 9:00 am–5:00 pm PST/PDT
at support@levoit.com or at (888) 726-8520.

TABLE OF CONTENTS

Specifications	2
Safety Information	3
Getting to Know Your Air Purifier	4
Controls	5
Getting Started	6
Using Your Purifier	8
· Memory Function	8
About the Filters	9
Care & Maintenance	10
· Cleaning the Air Purifier	10
· Check Filter Indicator	10
· Resetting the Check Filter Indicator	10
· Cleaning the Filters	10
· When Should I Replace the Filters?	11
· Replacing the Filters	11
· Storage	11
Troubleshooting	12
Warranty Information	14
Customer Support	15

PACKAGE CONTENTS

1-Pack

- 1 x Air Purifier
- 1 x H13 True HEPA Combination Filter/
Pre-Filter Set (Pre-Installed)
- 1 x User Manual

2-Pack

- 2 x Air Purifier
- 2 x H13 True HEPA Combination Filter/
Pre-Filter Set (Pre-Installed)
- 1 x User Manual

SPECIFICATIONS

Power Supply	AC 120V, 60Hz
Rated Power	28W
Ideal Room Size	129 ft ² / 12 m ² <i>Note: Effective for larger rooms, but purification will take longer.</i>
Operating Conditions	Temperature: 14°–104°F / -10°–40°C
	Humidity: ≤ 85% RH
Noise Level	≤ 50dB
Standby Power	< 0.8W
Air Purifier Dimensions	7.9 x 7.9 x 12.6 in / 20 x 20 x 32 cm
Air Purifier Weight	6 lb / 2.7 kg

READ AND SAVE THESE INSTRUCTIONS

SAFETY INFORMATION

To reduce the risk of fire, electric shock, or other injury, follow all instructions and safety guidelines.

General Safety

- **Only** use your air purifier as described in this manual.
- **Do not** use without removing the plastic wrap from the filters. The air purifier will not filter air, and may overheat, causing a fire hazard.
- **Do not** use the air purifier outdoors.
- Keep the air purifier away from water, and wet or damp areas. **Never** place in water or liquid.
- **Do not** use in excessively humid areas
- Keep the air purifier away from heat sources.
- **Do not** use where combustible gases, vapors, metallic dust, aerosol (spray) products, or fumes from industrial oil are present.
- Keep 5 ft / 1.5 m away from where oxygen is being administered.
- Supervise children when they are near the air purifier.
- **Do not** place anything into any opening on the air purifier.
- **Do not** sit on or place heavy objects on the air purifier.
- Keep the inside of the air purifier dry. To prevent moisture buildup, avoid placing in rooms with major temperature changes or underneath air conditioners.
- **Always** unplug the air purifier before servicing (such as changing filters).
- **Do not** use the air purifier if it is damaged or not working correctly, or if the cord or plug is damaged. **Do not** try to repair it yourself. Contact **Customer Support** (see page 15).
- **WARNING:** To reduce the risk of fire or electric shock, **do not** use this air purifier with solid-state speed controls (such as a dimmer switch).
- Not for commercial use. Household use **only**.

Power

- Keep air purifier near the outlet it is plugged into.
- **Never** place the cord near any heat source.
- **Do not** cover the cord with a rug, carpet, or other covering. **Do not** place the cord under furniture or appliances.
- Keep the cord out of areas where people walk often. Place the cord where it will not be tripped over.
- This appliance has a polarized plug (one blade is wider than the other). To reduce the risk of electric shock, this plug is intended to fit in a polarized outlet only one way. If the plug does not fit fully in the outlet, reverse the plug. If it still does not fit, contact a qualified electrician. **Do not** attempt to defeat this safety feature.

Electromagnetic Fields (EMF)

Your Levoit air purifier complies with all standards regarding electromagnetic fields (EMF). If handled properly and according to the instructions in this user manual, the appliance is safe to use based on scientific evidence available today.

GETTING TO KNOW YOUR AIR PURIFIER

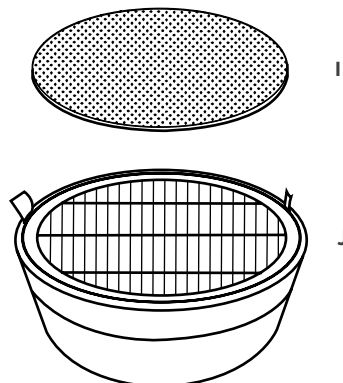
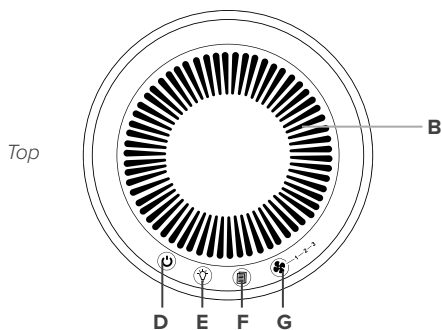

Top view of filter

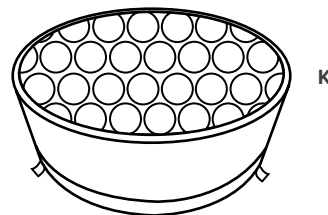
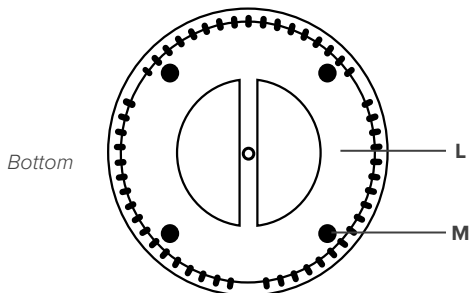

Bottom view of filter

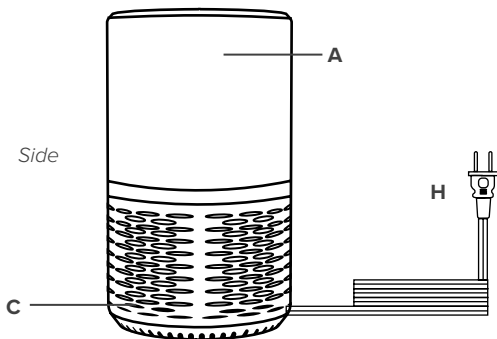

- | | |
|-------------------------------------|------------------------------------|
| A. Housing | H. Power Cord |
| B. Air Outlet | I. Pre-Filter |
| C. Air Inlet | J. True HEPA
Combination Filter |
| D. On/Off Button | K. Activated Carbon Filter |
| E. Night Light Button | L. Filter Cover |
| F. Check Filter Indicator
Button | M. Anti-Skid Pads |
| G. Fan Speed Button | |

CONTROLS



On/Off Button

- Turns the air purifier on/off.



Check Filter Indicator

- Lights up when the filters need to be checked (see **Checking the Air Filters** on page 10).



Night Light Button

- Cycles through night light settings: high, low, and off.
- Press and hold to turn off all lights on the air purifier, including button lights. Pressing any button (except ) will turn button lights back on.



Fan Speed Button

- Cycles through fan speeds: 1 (low), 2 (medium), and 3 (high).

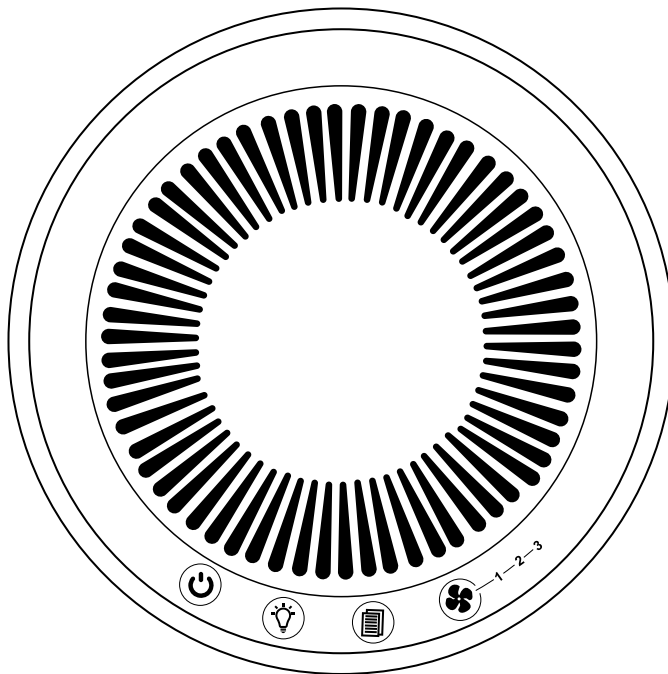

GETTING STARTED

1. Flip over the air purifier. Locate the “OPEN” and “LOCK” labels printed on the bottom of the air purifier, near the power cord inlet.
2. Twist the filter cover counterclockwise to the “OPEN” position, lining up the arrow on the filter cover with the arrow labeled “OPEN”. [Figures 1.1] Lift the cover off the air purifier.

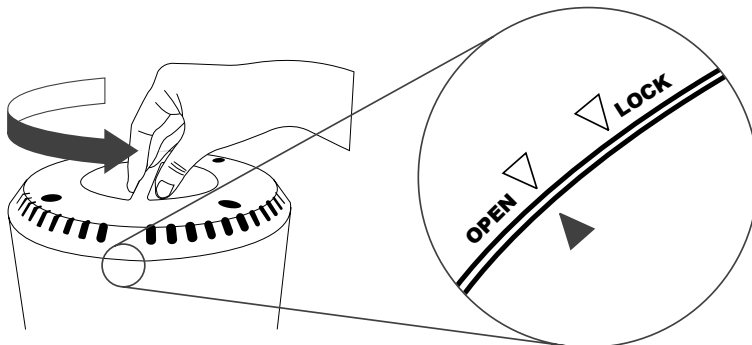

Figure 1.1

3. Remove the filters from their plastic packaging.
4. Place the True HEPA Combination Filter into the air purifier with the pull tabs facing out. Then, place the Pre-Filter into the air purifier. [Figures 1.2 & 1.3]

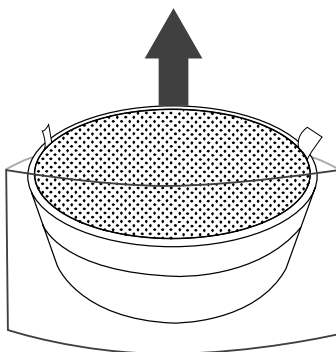

Figure 1.2

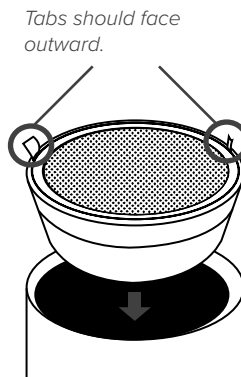

Figure 1.3

GETTING STARTED (cont.)

5. Replace the filter cover on the air purifier. Line up the arrow on the filter cover with the arrow labeled "OPEN". Then, twist the cover clockwise until the arrow on the cover lines up with the arrow labeled "LOCK". The cover should lock in place. [Figure 1.4]

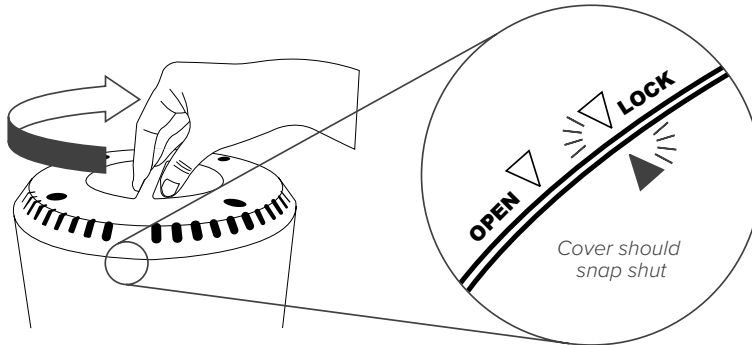

Figure 1.4

6. Place the air purifier on a flat, stable surface with the display facing up. Leave at least 15 inches / 38 cm of clearance on all sides of the air purifier. [Figure 1.5]

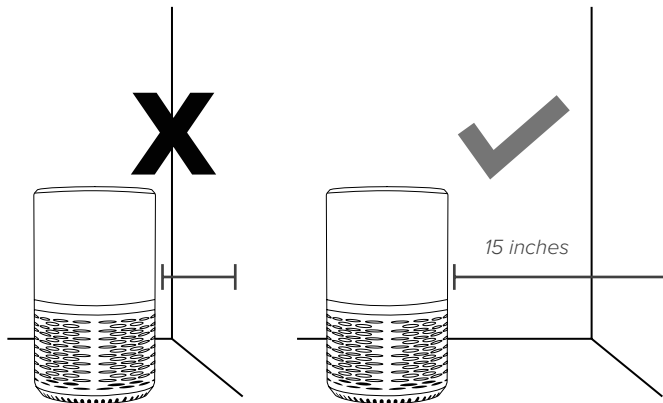





Figure 1.5

USING YOUR AIR PURIFIER

1. Plug in and tap  to turn on the air purifier. The air purifier fan will start automatically.
2. Optionally, tap  to change fan speed.

Note:

- *For best results, or to address a specific air quality issue such as smoke, run the air purifier at maximum speed (level 3) for 15–20 minutes before using a lower speed.*
 - *To effectively clean air, keep windows and doors closed while the air purifier is on.*
3. Tap  to turn off the air purifier.

Memory Function

When the air purifier is plugged in, it will remember its programmed settings for the fan speed and night light when turned off. The air purifier will resume these settings when turned back on.

ABOUT THE FILTERS

This air purifier uses a 3-stage filtration system to purify air.

A. Pre-Filter

- Captures large particles such as dust, lint, fibers, hair, and pet fur.
- Maximizes the life of the True HEPA Filter by protecting it.

B. H13 True HEPA Filter

- Captures at least 99.97% of airborne particles 0.3 microns (μm) in size.
- Filters small particles such as fine dust, smoke particles, and allergens such as pollen and pet dander.

C. High-Efficiency Activated Carbon Filter

- Physically adsorbs smoke, odors, and fumes.
- Filters compounds such as formaldehyde, benzene, ammonia, hydrogen sulfide, and volatile organic compounds (VOCs).

Note: Levoit air purifiers filter airborne particles 0.3 microns in size. Arovast Corporation makes no claims that this air purifier helps reduce the COVID-19 virus.

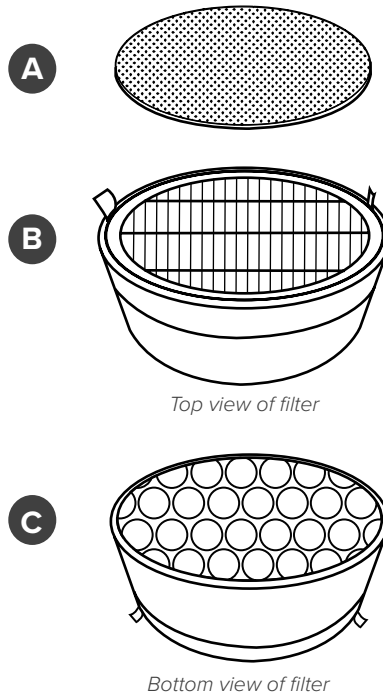

Humidity

Moisture may damage the filters. This air purifier should be used in an area with a humidity level below 85% RH. If you use the air purifier in excessively humid areas, the surface of the filters will become moldy.

Note: Water or moisture will allow mold to grow. To solve a mold problem, get rid of the source of the moisture and clean up the mold.

Essential Oils

Do not add essential oils to the air purifier or filter. The filters will become damaged by the oil and will eventually release an unpleasant smell. **Do not** use oil diffusers near the air purifier.

CARE & MAINTENANCE

Cleaning the Air Purifier





- Unplug before cleaning.
- Wipe the outside of the air purifier with a soft, dry cloth. If necessary, wipe the housing with a damp cloth, then immediately dry.
- **Do not** clean with abrasive chemicals or flammable cleaning agents.

Check Filter Indicator

The Check Filter Indicator  will light up as a reminder to check the filters. Depending on how much you use the air purifier, the indicator should turn on within 6–8 months. You may not need to change your filters yet, but you should check them when the indicator light turns on.

Resetting the Check Filter Indicator

Reset the Check Filter Indicator when:

-  lights up.
 1. Replace the filters (see page 11).
 2. While the air purifier is plugged in and turned on, press and hold  for 3 seconds until the air purifier beeps.
 3. The light will turn off once it is successfully reset.
- The filters were changed before  lit up.
 1. While the air purifier is plugged in and turned on, press and hold  for 3 seconds until the air purifier beeps. This will turn the indicator light on.
 2. Press and hold  again for 3 seconds until the air purifier beeps.
 3. The light will turn off once it is successfully reset.

Cleaning the Filters

- A. The Pre-Filter should be cleaned once a month to increase efficiency and extend the life of your filters. Clean the Pre-Filter using a brush to remove hair, dust, and large particles. Optionally, rinse the Pre-Filter in clean water.

Note: *Always make sure the Pre-Filter is completely dry before using, because dampness or moisture will damage the True HEPA Filter.*

- B. **Do not** clean the True HEPA Combination Filter. Fine dust or bacteria may be released back into the air if cleaning is attempted, and the filter will be permanently damaged. **Only** clean the Pre-Filter.

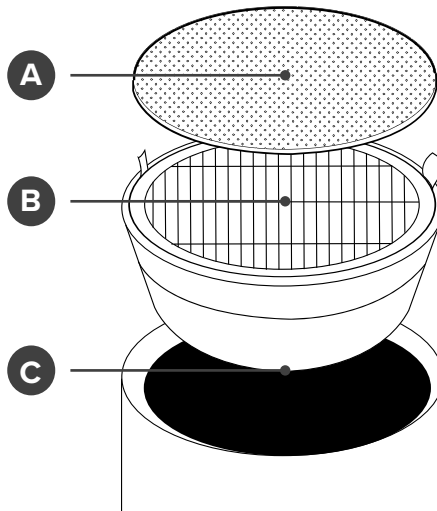

CARE & MAINTENANCE (cont.)

When Should I Replace the Filters?

The filters should be replaced every 6–8 months. You may need to replace your filters earlier or later depending on how often you use your air purifier. Using your air purifier in an environment with relatively high pollution may mean you will need to change the filters more often (even if the Check Filter Indicator is off).

You may need to replace your filters if you notice:

- Increased noise when the air purifier is on
- Decreased airflow
- Unusual odors
- Visibly clogged filters

Note: *To maintain the performance of your air purifier, only use official Levoit filters. To buy replacement filters, visit Levoit's online store. Go to [levoit.com](https://www.levoit.com) for more information.*



Replacing the Filters

1. Unplug the air purifier. Flip the air purifier over and remove the filter cover (see page 8).
2. Remove the old filters.
3. Clean any remaining dust or hair inside the air purifier using a vacuum hose. Do not use water or liquids to clean the air purifier.
4. Unwrap the new filters and place them into the housing (see page 6).
5. Replace the cover and plug in the air purifier.
6. Reset the Check Filter Indicator (see page 10).

Storage

If not using the air purifier for an extended period of time, wrap both the air purifier and the filters in plastic packaging and store in a dry place to avoid moisture damage.

TROUBLESHOOTING

Problem	Possible Solution
Air purifier will not turn on or respond to button controls.	Plug in the air purifier.
	Check to see if the power cord is damaged. If it is, stop using the air purifier and contact Customer Support (see page 15).
	Plug the air purifier into a different outlet.
	The air purifier may be malfunctioning. Contact Customer Support (see page 15).
Airflow is significantly reduced.	Make sure the filters are removed from their packaging and properly in place (see page 6).
	Tap  to increase the fan speed.
	Leave 15 inches / 38 cm of clearance on all sides of the air purifier.
	Replace the filters (see page 11).
Air purifier makes an unusual noise while the fan is on.	Make sure the filters are properly in place with plastic packaging removed (see page 6).
	Make sure the air purifier is operating on a hard, flat, even surface.
	Replace the filters (see page 11).
	The air purifier may be damaged, or a foreign object may be inside. Stop using the air purifier and contact Customer Support (see page 15). Do not try to repair the air purifier.
Poor air purification quality.	Tap  to increase the fan speed.
	Make sure no objects are blocking the sides or top of the air purifier (the inlet or outlet).
	Make sure the filters are removed from their packaging and properly in place (see page 6).
	Close doors and windows while using the air purifier.
	If the room is larger than 129 ft ² / 12 m ² , air purification will take longer. The air purifier may not be as effective in significantly larger rooms.
	Replace the filters (see page 11).

TROUBLESHOOTING (cont.)

Problem	Possible Solution
The Check Filter Indicator is still on after replacing the filters.	Reset the Check Filter Indicator (see page 10).
The Check Filter Indicator has not turned on within 8 months.	The Check Filter Indicator is a reminder for you to check the filters and will light up based on how much the air purifier has been used (see page 11). If you don't use your air purifier often, the indicator will take longer to turn on.
The Check Filter Indicator turned on before 6 months.	The Check Filter Indicator is a reminder for you to check the filters and will light up based on how much the air purifier has been used (see page 11). If you run your air purifier frequently, the indicator will turn on sooner.
Air does not flow evenly out of the air purifier.	This is due to the design of the air purifier. This is normal and will not affect the air purifier's efficiency.

If your problem is not listed, please contact **Customer Support** (see page 15).

WARRANTY INFORMATION

Product	Personal True HEPA Air Purifier
Model	LV-H132, LV-H132XR
<i>For your own reference, we strongly recommend that you record your order ID and date of purchase.</i>	
Order ID	
Date of Purchase	

Terms & Policy

Arovast Corporation ("Arovast") warrants this product to the original purchaser to be free from defects in material and workmanship, under normal use and conditions, for a period of 1 year from the date of original purchase.

Arovast agrees, at our option during the warranty period, to repair any defect in material or workmanship or furnish an equal product in exchange without charge, subject to verification of the defect or malfunction and proof of the date of purchase.

There is no other express warranty. This warranty does not apply:

- If the product has been modified from its original condition;
- If the product has not been used in accordance with directions and instructions in the user manual;
- To damages or defects caused by accident, abuse, misuse or improper or inadequate maintenance;
- To damages or defects caused by service or repair of the product performed by an unauthorized service provider or by anyone other than Arovast;
- To damages or defects occurring during commercial use, rental use, or any use for which the product is not intended;
- To damages or defects exceeding the cost of the product.

Arovast will not be liable for indirect, incidental, or consequential damages in connection with the use of the product covered by this warranty.

This warranty extends only to the original consumer purchaser of the product and is not transferable to any subsequent owner of the product regardless of whether the product is transferred during the specified term of the warranty.

This warranty does not extend to products purchased from unauthorized sellers. Arovast's warranty extends only to products purchased from authorized sellers that are subject to Arovast's quality controls and have agreed to follow its quality controls.

All implied warranties are limited to the period of this limited warranty.

This warranty gives you specific legal rights and you may also have other rights which vary from state to state. Some states do not allow the exclusion or limitation of incidental or consequential damages, so the above limitation or exclusion may not apply to you.

If you discover that your product is defective within the specified warranty period, please contact Customer Support via support@levoit.com. **DO NOT** dispose of your product before contacting us. Once our Customer Support Team has approved your request, please return the product with a copy of the invoice and order ID.

Extend Your Warranty by 1 Year

Register your product within 14 days of purchase at www.levoit.com/warranty to extend your 1-year warranty by an additional year.

This warranty is made by:

Arovast Corporation
1202 N. Miller St. Suite A
Anaheim, CA 92806

CUSTOMER SUPPORT

If you have any questions or concerns about your new product, please contact our helpful Customer Support Team.

Distributed by Arovast Corporation

1202 N. Miller St., Suite A
Anaheim, CA 92806

Email: support@levoit.com

Toll-Free: (888) 726-8520

Support Hours

Mon–Fri, 9:00 am–5:00 pm PST/PDT

**Please have your order invoice or order ID ready before contacting Customer Support.*

levoit®

levoit.com

Connect with us @LevoitLifestyle

