

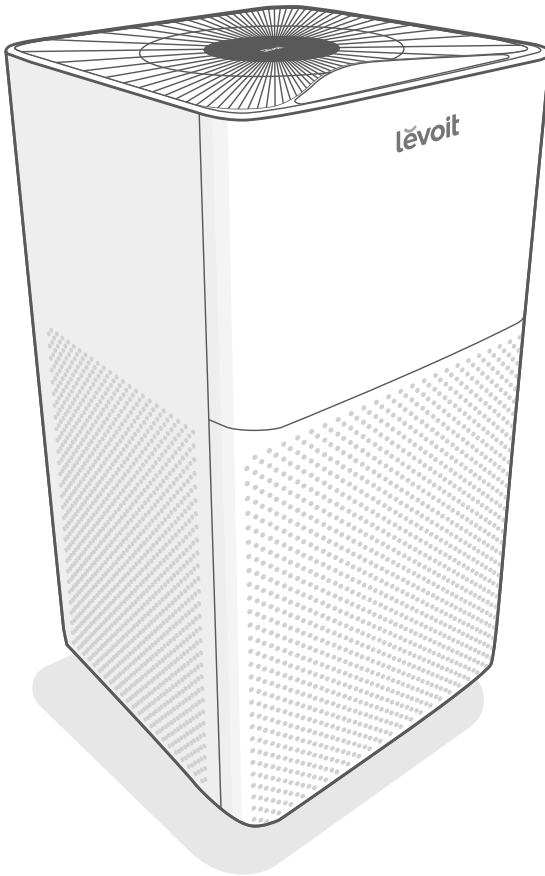

USER MANUAL

# Console True HEPA Air Purifier

Model: LV-H135



## Questions or Concerns?

Please contact us Mon-Fri, 9:00 am–5:00 pm PST/PDT at [support@levoit.com](mailto:support@levoit.com) or at (888) 726-8520.

## Table of Contents

Package Contents	2
Specifications	2
Safety Information	3
Getting to Know Your Air Purifier	4
LED Display	5
Getting Started	6
Using Your Air Purifier	8
About the Filter	10
Care & Maintenance	12
Troubleshooting	16
Warranty Information	18
Customer Support	19

## Package Contents

- 1 x Air Purifier
- 1 x 3-Stage Filter (Pre-Installed)
- 1 x User Manual

## Specifications

<b>Power Supply</b>	AC 120V, 60Hz
<b>Rated Power</b>	40W
<b>Ideal Room Size</b>	463 ft <sup>2</sup> / 43 m <sup>2</sup> <b>Note:</b> <ul style="list-style-type: none"><li>• Effective for larger rooms, but purification will take longer.</li><li>• Ideal Room Size is based on 3.4 air changes per hour (ACH).</li></ul>
<b>Operating Conditions</b>	<b>Temperature:</b> 14°–104°F / -10°–40°C <b>Humidity:</b> ≤ 85% RH
<b>Noise Level</b>	≤ 54dB
<b>Clean Air Delivery Rate (CADR)</b>	212 CFM / 360 m <sup>3</sup> /h
<b>Dimensions</b>	20.9 x 11.2 x 11.2 in / 53 x 28 x 28 cm
<b>Weight</b>	13.7 lb / 6.2 kg

# READ AND SAVE THESE INSTRUCTIONS

## SAFETY INFORMATION

To reduce the risk of fire, electric shock, or other injury, follow all instructions and safety guidelines.

### General Safety

- **Only** use your air purifier as described in this manual.
- **Do not** use without removing the plastic wrap from the filter. The air purifier will not filter air, and may overheat, causing a fire hazard.
- **Do not** use the air purifier outdoors.
- Keep the air purifier away from water, and wet or damp areas. **Never** place in water or other liquids.
- **Do not** use in excessively humid areas.
- Keep the air purifier away from heat sources.
- **Do not** use where combustible gases or vapors, metallic dust, aerosol (spray) products, or fumes from industrial oil are present.
- Keep 5 ft / 1.5 m away from where oxygen is being administered.
- Supervise children when they are near the air purifier.
- **Do not** place anything into any opening on the air purifier, unless directed by the manual.
- **Do not** sit or place heavy objects on the air purifier.
- Keep the inside of the air purifier dry. To prevent moisture buildup, avoid placing in rooms with major temperature changes.
- **Always** unplug the air purifier before servicing (for example, changing the filter).
- **Do not** use the air purifier if it is damaged or not working correctly, or if the cord or plug is damaged.  
**Do not** try to repair it yourself. **Contact Customer Support** (see page 19).

- **WARNING:** To reduce the risk of fire or electric shock, **do not** use this air purifier with any solid-state speed controls (such as a dimmer switch).
- Not for commercial use. Household use **only**.

### Power & Cord

- Keep the air purifier near the outlet it is plugged into.
- **Never** place the cord near any heat source.
- **Do not** cover the cord with a rug, carpet, or other covering. **Do not** place the cord under furniture or appliances.
- Keep the cord out of areas where people walk often. Place the cord where it will not be tripped over.
- This air purifier has a polarized plug (one blade is wider than the other). To reduce the risk of electric shock, this plug is intended to fit in a polarized outlet only one way. If the plug does not fit fully in the outlet, reverse the plug. If it still does not fit, contact a qualified electrician. **Do not** attempt to defeat this safety feature.

### Electromagnetic Fields (EMF)

Your Levoit air purifier complies with all standards regarding electromagnetic fields (EMF). If handled properly and according to the instructions in this user manual, the appliance is safe to use based on scientific evidence available today.

# GETTING TO KNOW YOUR AIR PURIFIER

- A. LED Display
- B. Air Outlet
- C. Housing
- D. Air Intake (Front and Back)
- E. Air Quality Sensor
- F. Sensor Cover Sponge
- G. Sensor Cover
- H. Safety Trigger
- I. Filter Cover
- J. Filter
- K. Power Cord

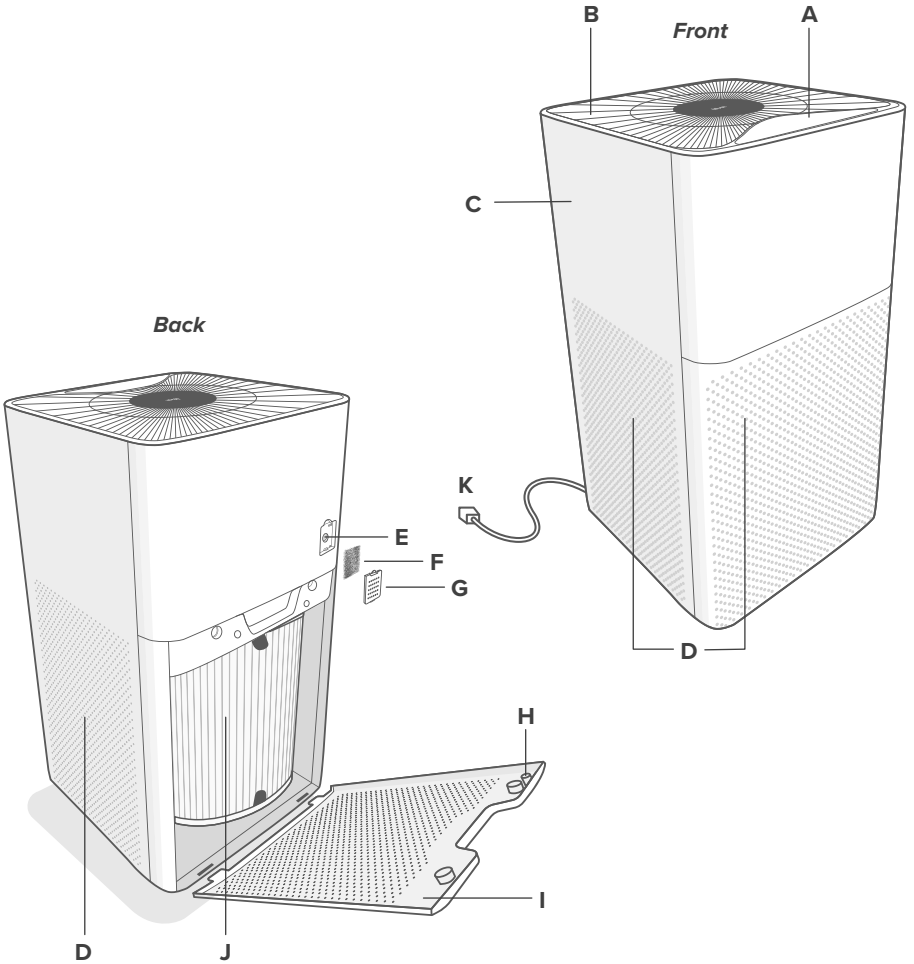



# LED DISPLAY

## Controls

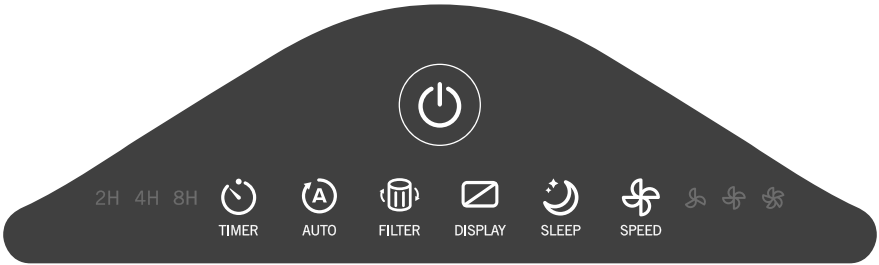

### On/Off Button

- Turns the air purifier on/off.



### Display Off Button

- Turns the display off.
- Press any button (except ) to turn the display back on.



### Timer Button

- Sets the timer and cycles through timer lengths (see page 8).



### Fan Speed Button



- Cycles through fan speeds: low, medium, and high.

*Fan Speed Chart*



### Auto Mode Button

- Turns Auto Mode on/off (see page 8).

Fan Speed	Fan Speed Indicator
Low	
Medium	
High	



### Check Filter Indicator

- Lights up when the filter should be checked (see **Check Filter Indicator**, page 12).



### Sleep Mode Button

- Turns Sleep Mode on/off (see page 8).

# GETTING STARTED

1. Pull the handle of the filter cover to open the housing. Remove the filter from the housing. [Figure 1.1]

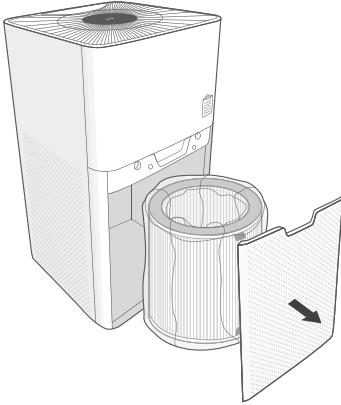

Figure 1.1

2. Remove the filter from its plastic packaging, then reinstall it into the housing. Make sure the pull tabs on the filter are facing out. [Figure 1.2]

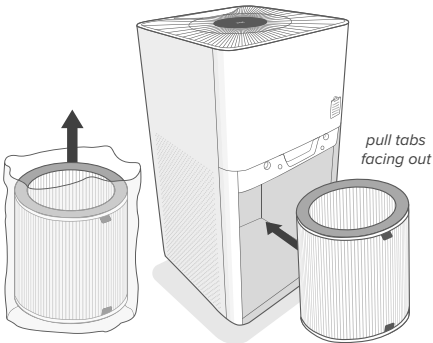

Figure 1.2

3. Replace the filter cover by lining up the cover's feet with the slots on the bottom of the housing. [Figure 1.3]

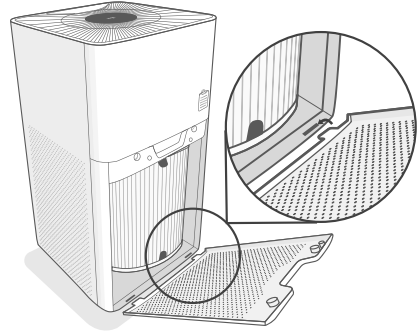
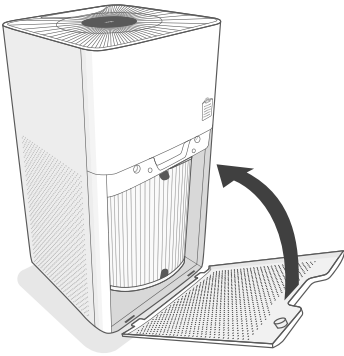

Figure 1.3

## GETTING STARTED (CONT.)

4. Push the cover securely closed.  
*[Figure 1.4]* The air purifier uses a magnetic safety trigger to make sure that the filter cover is closed. If not properly closed, the air purifier **will not** turn on.



*Figure 1.4*

5. Place the air purifier on a hard, flat surface. Leave 15 in / 38 cm of clearance on all sides of the air purifier.  
*[Figure 1.5]*

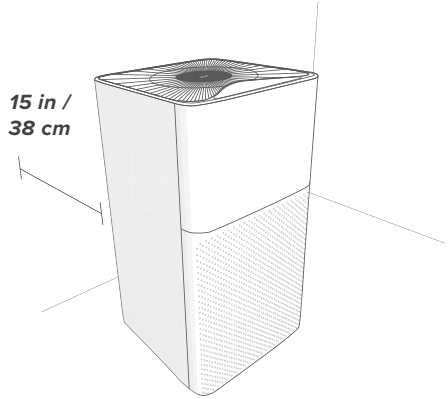



*Figure 1.5*

**Note:** If you are not planning to use the air purifier for a long period of time, we recommend keeping the filter clean by leaving it inside its plastic packaging until it is ready to be used.

# USING YOUR AIR PURIFIER

## General Operation



1. Plug in and press  to turn the air purifier on/off. The fan will start automatically.
2. Optionally, press  to change the fan speed. You can also select Auto Mode or Sleep Mode, or select a timer.

### Note:

- For best results, or to address a specific air quality issue such as smoke, run the air purifier at high speed for 15–20 minutes before using a lower speed or Auto Mode.
- To effectively clean air, keep windows and doors closed while the air purifier is operating.

## Auto Mode

Auto Mode uses the dust sensor inside the air purifier to adjust the fan speed automatically based on air quality. For example, if the air quality is bad, the fan will automatically be set to high speed.



- Press  to turn Auto Mode on/off.
- Pressing  or  will also exit Auto Mode.

## Automatic Shutoff

As a safety feature, the air purifier will automatically turn off if the filter cover is removed.

## Sleep Mode

Sleep Mode uses the lowest possible fan speed to create a quiet environment.

- Press  to turn Sleep Mode on/off.
- Pressing  or  will also exit Sleep Mode.

## Timer

- You can set a timer for 2, 4, or 8 hours.
- Press  to cycle through timer options and turn the timer off. The timer will start automatically.
- Once the timer has finished, the air purifier will turn off.

### Note:

- You can change the fan speed at any time while the timer is on. The timer will work with any mode.
- The timer will restart if the time is changed.
- Pressing  or unplugging the air purifier will cancel the timer.

## Memory Function

The air purifier will remember its programmed settings when turned off, and will resume these settings when turned back on.

**Note:** The air purifier will not remember timers.

## USING YOUR AIR PURIFIER (CONT.)

### Air Quality Indicator

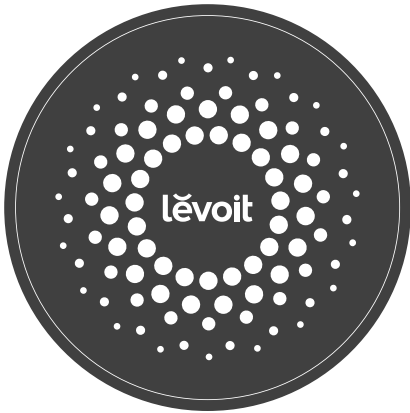

This indicator uses an automatic sensor to display the air quality.

*Air Quality Indicator Chart*

Indicator Color	Air Quality	Fan Speed
Blue	Very Good	Sleep Mode
Green	Good	Low
Yellow	Moderate	Medium
Red	Bad	High

### Changing Brightness

Use the palm of your hand to press the air quality indicator to change the brightness.

**Note:** *Touching with just a fingertip may not change the brightness.*

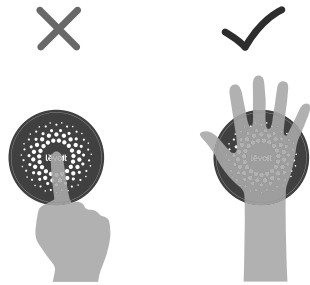

## USING YOUR AIR PURIFIER (CONT.)

### About the Filter

This air purifier uses a 3-stage filtration system to purify air.

#### A. Nylon Pre-Filter

- Captures large particles such as dust, lint, fibers, hair, and pet fur.
- Maximizes the life of the True HEPA Filter by protecting it.

#### B. H13 True HEPA Filter

- Captures at least 99.97% of airborne particles 0.3 microns ( $\mu\text{m}$ ) in size.
- Traps small particles such as fine dust, smoke particles, and allergens such as pollen and pet dander.

#### C. Custom High-Efficiency Activated Carbon Filter

- Physically adsorbs smoke, odors, and fumes.
- Customized using Levoit's exclusive ARC Formula™ to be especially effective for cooking smells and pet odors in a multi-pet household.
- The ARC Formula extends the life of the filter by chemically decomposing molecules trapped within the Activated Carbon Filter, which prevents oversaturation and second-hand pollution.
- Filters compounds such as formaldehyde, benzene, ammonia, hydrogen sulphide, and volatile organic compounds (VOCs).

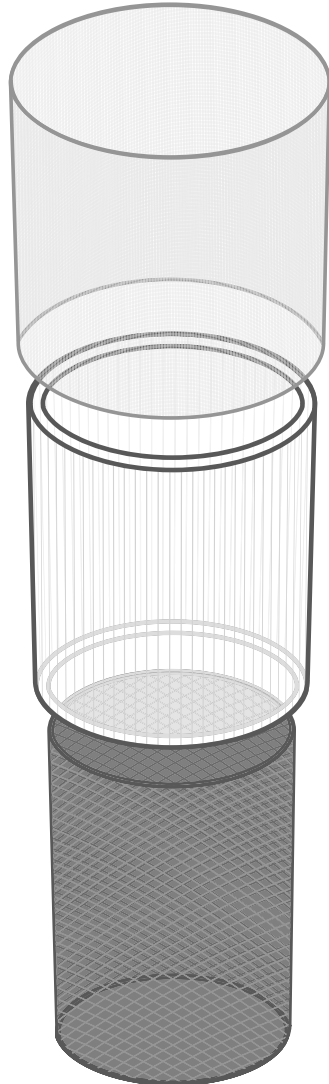

**Note:** Levoit air purifiers filter airborne particles 0.3 microns in size. Arovast Corporation makes no claims that this air purifier helps reduce the COVID-19 virus.

## USING YOUR AIR PURIFIER (CONT.)

### Clean Air Delivery Rate

This air purifier has a Clean Air Delivery Rate of 212 cubic feet per minute (CFM), or 360 m<sup>3</sup>/h.

Clean Air Delivery Rate (CADR) measures the efficiency of an air purifier by indicating the volume of clean air that an air purifier produces per minute. This is based on removal of dust, pollen, and smoke, which are the 3 most common indoor air pollutants. The higher the CADR, the more particles the air purifier will remove and the larger the area it can clean. The rating is measured at the air purifier's highest speed.

### Humidity

Moisture may damage the filter. This air purifier should be used in an area with a humidity level below 85% RH. If you use the air purifier in excessively humid areas, the surface of the filter will become moldy.

**Note:** *Water or moisture will allow mold to grow. To solve a mold problem, get rid of the source of the moisture and clean up the mold.*

### Air Change Per Hour

The air change rate (ACH) is how many times all of the air in a room can be purified (or “changed”) by the air purifier in 1 hour. Air changes per hour are calculated on the recommended room size assuming 8 ft / 2.4 m ceilings. For smaller rooms, the air change per hour will increase. This air purifier has an air change per hour of 3.4, which means it can change air 3.4 times at the max speed in a single, closed room up to 463 ft<sup>2</sup> / 43 m<sup>2</sup>. The air purifier is effective for larger rooms, but air purification will take longer, with fewer air changes per hour.

**Note:** *To effectively clean air, keep windows and doors closed while the air purifier is on.*

### Essential Oils

**Do not** add essential oils to the air purifier or filter. The filters will become damaged by the oil and will eventually release an unpleasant smell. **Do not** use oil diffusers near the air purifier.

# CARE & MAINTENANCE

## Cleaning the Air Purifier

**Note:** Do not clean with abrasive chemicals or flammable cleaning agents.

1. Unplug before cleaning.
2. Wipe the outside of the air purifier with a soft, dry cloth. If necessary, wipe the housing with a damp cloth, then immediately dry.
3. Vacuum the inside of the air purifier.

## Cleaning the Sensor Cover

If the air quality indicator does not seem to be accurate, clean the sensor cover.

1. Remove the sensor cover. [Figure 2.1]

**Note:** The sensor cover has a sponge inside to protect the air quality sensor from large particles.

2. Wipe the cover with a dry cloth. Wash the sponge with clean water, then dry.
3. Replace the sponge into the sensor cover, and then replace the sensor cover.

**Note:** Do not throw away the sponge. If the sponge is not in the sensor cover, the air quality sensor may not work correctly.

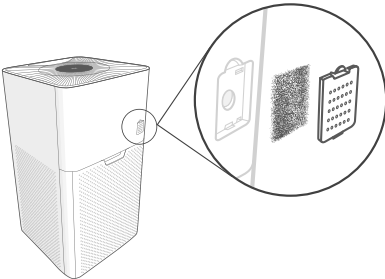









Figure 2.1

## Check Filter Indicator

 will light up as a reminder to check the filter. Depending on how often you use the air purifier, the indicator should turn on within 6–8 months. You may not need to replace your filter yet, but you should check it when  turns on.

## Resetting the Check Filter Indicator

Reset the Check Filter Indicator when:

-  lights up.
  1. Replace the filter (see page 14).
  2. Turn on the air purifier.
  3. Press and hold  for 3 seconds.
  4. The light will turn off after the filter indicator is successfully reset.
- The filter was changed before  lit up.
  1. Press and hold  for 3 seconds until  lights up.
  2. Press and hold  again for 3 seconds.
  3. The light will turn off after the filter indicator is successfully reset.



## CARE & MAINTENANCE (CONT.)

### When Should I Replace the Filter?

The filter should be replaced every 6–8 months. You may need to replace your filter earlier or later depending on how often you use your air purifier. Using your air purifier in an environment with relatively high pollution may mean you will need to change the filter more often, even if  is off.

You may need to replace your filter if you notice:

- Increased noise when the air purifier is on
- Decreased airflow
- Unusual odors
- A visibly clogged filter

**Note:**

- *To maintain the performance of your air purifier, **only** use official Levoit filters. To buy replacement filters, visit Levoit's online store. Go to **levoit.com** for more information.*
- *Remember to reset  after changing the filter.*

## Replacing the Filter

1. Unplug the air purifier and remove the filter cover. [Figure 2.2]

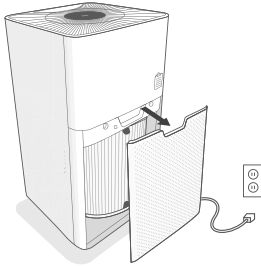

Figure 2.2

2. Remove the old filter. [Figure 2.3]

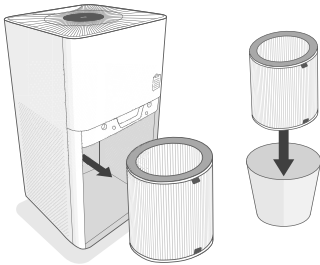

Figure 2.3

3. Clean out any remaining dust or hair inside the air purifier using a vacuum hose. **Do not** use water or liquids to clean the air purifier. [Figure 2.4]

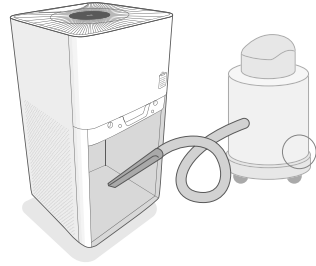

Figure 2.4

4. Unwrap the new filter and place it into the housing. Make sure the pull tabs are facing out. [Figure 2.5]

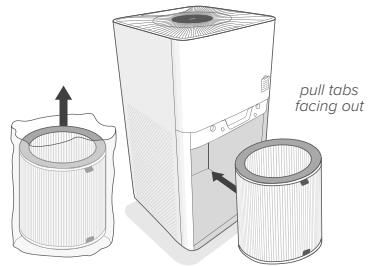

Figure 2.5

## Replacing the Filter (cont.)

5. Replace the filter cover. The air purifier will not power on unless the cover is replaced correctly. [Figure 2.6]

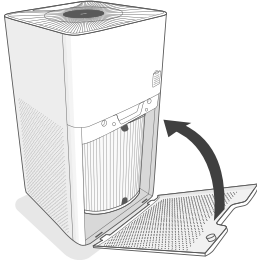



Figure 2.6

6. Plug in and turn on the air purifier.
7. Reset the Check Filter Indicator (see page 12).









## Storage

If not using the air purifier for an extended period of time, wrap the filter in plastic packaging and store in a dry place to avoid moisture damage.

# TROUBLESHOOTING

Problem	Possible Solution
<p><b>Air purifier will not turn on or respond to button controls.</b></p>	<p>Plug in the air purifier.</p>
	<p>Check to see if the power cord is damaged. If it is, stop using the air purifier and contact <b>Customer Support</b> (see page 19).</p>
	<p>Securely close the filter cover so that the safety switch is activated (see page 7).</p>
	<p>Plug the air purifier into a different outlet.</p>
	<p>Air purifier is malfunctioning. Contact <b>Customer Support</b> (see page 19).</p>
<p><b>Air purifier makes an unusual noise while the fan is on.</b></p>	<p>Make sure the filter is removed from its packaging and properly in place (see page 6).</p>
	<p>Replace the filter (see page 14).</p>
	<p>Air purifier may be damaged, or a foreign object may be inside. Stop using the air purifier and contact <b>Customer Support</b> (see page 19). <b>Do not</b> try to repair the air purifier.</p>
<p><b>Airflow is significantly reduced.</b></p>	<p>Make sure the filter is properly in place with plastic packaging removed (see page 6).</p>
	<p>Press  to increase the fan speed.</p>
	<p>Make sure there is clearance of at least 15 in / 38 cm on all sides of the air purifier.</p>
	<p>The pre-filter may be clogged by large particles, such as hair or lint, blocking airflow. Clean the pre-filter (see page 12).</p>
	<p>Replace the filter (see page 14).</p>

TROUBLESHOOTING (CONT.)

Problem	Possible Solution
<p>Poor air purification quality.</p>	<p>Press  to increase the fan speed.</p>
	<p>Make sure no objects are blocking the top or sides of the air purifier (the inlet or outlet).</p>
	<p>Close doors and windows while running the air purifier.</p>
	<p>Make sure the filter is removed from its packaging and properly in place (see page 6).</p>
	<p>Close doors and windows while running the air purifier.</p>
	<p>If the room is larger than 463 ft<sup>2</sup> / 43 m<sup>2</sup>, air purification will take longer. The air purifier may not be as effective in significantly larger rooms.</p>
	<p>Clean the sensor cover (see page 12).</p>
	<p>Replace the filter (see page 14).</p>
<p>Strange smell coming form the air purifier.</p>	<p>Clean the filter, or replace if necessary.</p>
	<p>Contact <b>Customer Support</b> (see page 19).</p>
	<p>Make sure not to use your air purifier in an area with high humidity (over 85% RH) or while diffusing essential oils.</p>
<p> is still illuminated after replacing the filter.</p>	<p>Reset  (see page 12).</p>
<p> has not turned on within 8 months.</p>	<p> is a reminder for you to check the filter and will light up based on how much the air purifier has been used (see page 12). If you don't use your air purifier often,  will take longer to turn on.</p>
<p> turned on before 6 months.</p>	<p> is a reminder for you to check the filter and will light up based on how much the air purifier has been used (see page 12). If you run your air purifier frequently,  will turn on sooner.</p>

If your problem is not listed, please contact **Customer Support** (see page 19).

# FCC INTERFERENCE STATEMENT

This device complies with Part 15 of the FCC Rules. Operation is subject to the following two conditions:

(1) This device may not cause harmful interference, and (2) This device must accept any interference received, including interference that may cause undesired operation.

NOTE: This equipment has been tested and found to comply with the limits for a Class B digital device, pursuant to part 15 of the FCC Rules. These limits are designed to provide reasonable protection against harmful interference in a residential installation.

This equipment generates, uses and can radiate radio frequency energy and, if not installed and used in accordance with the instructions, may cause harmful interference to radio communications. However, there is no guarantee that interference will not occur in a particular installation. If this equipment does cause harmful interference to radio or television reception, which can be determined by turning the equipment off and on, the user is encouraged to try to correct the interference by one or more of the following measures:

- Reorient or relocate the receiving antenna.
- Increase the separation between the equipment and receiver.
- Connect the equipment into an outlet on a circuit different from that to which the receiver is connected.
- Consult the dealer or an experienced radio/TV technician for help.

**FCC Caution:** Any changes or modifications not expressly approved by the party responsible for compliance could void the user's authority to operate this equipment.

# WARRANTY INFORMATION

<b>Product</b>	Console True HEPA Air Purifier
<b>Model</b>	LV-H135
<i>For your own reference, we strongly recommend that you record your order ID and date of purchase.</i>	
<b>Order ID</b>	
<b>Date of Purchase</b>	

## Terms & Policy

Arovast Corporation ("Arovast") warrants this product to the original purchaser to be free from defects in material and workmanship, under normal use and conditions, for a period of 1 year from the date of original purchase.

Arovast agrees, at our option during the warranty period, to repair any defect in material or workmanship or furnish an equal product in exchange without charge, subject to verification of the defect or malfunction and proof of the date of purchase.

There is no other express warranty. This warranty does not apply:

- If the product has been modified from its original condition;
- If the product has not been used in accordance with directions and instructions in the user manual;
- To damages or defects caused by accident, abuse, misuse or improper or inadequate maintenance;
- To damages or defects caused by service or repair of the product performed by an unauthorized service provider or by anyone other than Arovast;
- To damages or defects occurring during commercial use, rental use, or any use for which the product is not intended;
- To damages or defects exceeding the cost of the product.

## TROUBLESHOOTING (CONT.)

Arovast will not be liable for indirect, incidental, or consequential damages in connection with the use of the product covered by this warranty.

This warranty extends only to the original consumer purchaser of the product and is not transferable to any subsequent owner of the product regardless of whether the product is transferred during the specified term of the warranty.

This warranty does not extend to products purchased from unauthorized sellers. Arovast's warranty extends only to products purchased from authorized sellers that are subject to Arovast's quality controls and have agreed to follow its quality controls.

All implied warranties are limited to the period of this limited warranty.

This warranty gives you specific legal rights and you may also have other rights which vary from state to state. Some states do not allow the exclusion or limitation of incidental or consequential damages, so the above limitation or exclusion may not apply to you.

If you discover that your product is defective within the specified warranty period, please contact Customer Support via **support@levoit.com**. **DO NOT** dispose of your product before contacting us. Once our Customer Support Team has approved your request, please return the product with a copy of the invoice and order ID.

## Extend Your Warranty by 1 Year

Register your product within 14 days of purchase at **www.levoit.com/warranty** to extend your 1-year warranty by an additional year.

This warranty is made by:

Arovast Corporation  
1202 N. Miller St., Suite A  
Anaheim, CA 92806

## CUSTOMER SUPPORT

### Distributed by Arovast Corporation

1202 N. Miller St., Suite A  
Anaheim, CA 92806

**Email:** support@levoit.com

**Toll-Free:** (888) 726-8520

### Support Hours

Mon–Fri, 9:00 am–5:00 pm PST/PDT

*\* Please have your order invoice and order ID ready before contacting Customer Support.*

# levoit®

levoit.com

Connect with us @LevoitLifestyle

