

# levoit

---

USER MANUAL

## True HEPA Air Purifier

Model: Vista 200

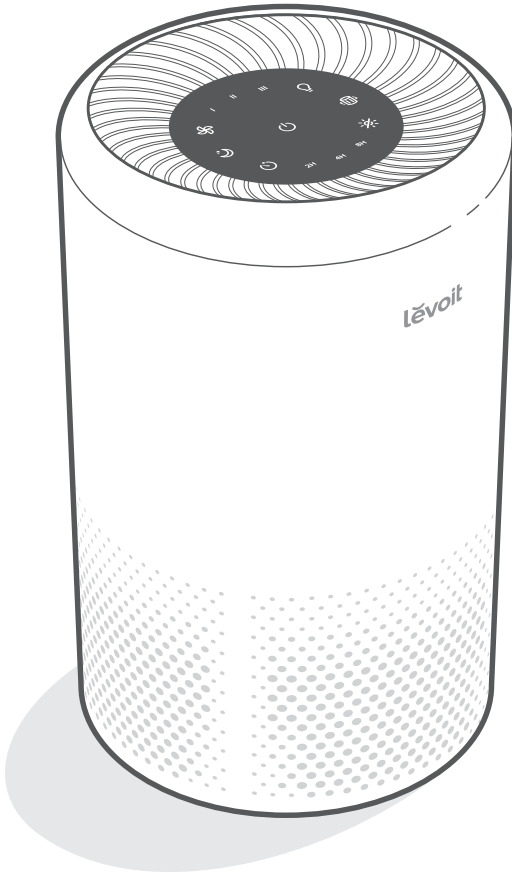

### Questions or Concerns?

Please contact us Mon–Fri, 9:00 am–5:00 pm PST/PDT at [support@levoit.com](mailto:support@levoit.com) or at **(888) 726-8520**.

Thank you for purchasing the  
**TRUE HEPA AIR  
PURIFIER BY LEVOIT.**

If you have any questions or concerns, please reach out to us at [support@levoit.com](mailto:support@levoit.com). We hope you enjoy your new air purifier!

**Find Us Online**

Search for **@LevoitLifestyle** • **#LevoitLove** • **#LevoitLifestyle** on social media for tips, special deals, giveaways, inspiration, and more.

## Table of Contents

Package Contents	3
Specifications	3
Safety Information	4
Getting to Know Your Air Purifier	5
Controls	6
Getting Started	6
Using Your Purifier	7
About the Filter	8
Care & Maintenance	9
Troubleshooting	11
Warranty Information	13
Customer Support	14

## Package Contents

- 1 x Air Purifier
- 1 x True HEPA Filter (Pre-Installed)
- 1 x Quick Start Guide
- 1 x User Manual

## Specifications

<b>Power Supply</b>	AC 120V, 60Hz
<b>Rated Power</b>	24W
<b>Effective Range</b>	$\leq 172 \text{ ft}^2 / 16 \text{ m}^2$
<b>Operating Conditions</b>	<b>Temperature:</b> 14°–104°F / -10°–40°C
	<b>Humidity:</b> < 85% RH
<b>Noise Level</b>	26–43dB
<b>Standby Power</b>	< 0.5W
<b>Dimensions</b>	7.9 x 7.9 x 12.9 in / 20 x 20 x 33 cm
<b>Weight</b>	5.2 lb / 2.4 kg

# SAFETY INFORMATION

To reduce the risk of fire, electric shock, or other injury, follow all instructions and safety guidelines.

## General Safety

- **Only** use your air purifier as described in this manual.
- **Do not** use without removing the plastic wrap from the filter. The purifier will not filter air, and may overheat, causing a fire hazard.
- **Do not** use your air purifier outdoors.
- Keep your air purifier away from water, and wet or damp areas. **Never** place in water or liquid.
- **Do not** use in excessively humid areas.
- Keep your air purifier away from heat sources.
- **Do not** use where combustible gases, vapors, metallic dust, aerosol (spray) products, or fumes from industrial oil are present.
- Keep 5 ft / 1.5 m away from where oxygen is being administered.
- Supervise children when they are near the air purifier.
- **Do not** place anything into any opening on the air purifier.
- **Do not** sit or place heavy objects on the air purifier.
- Keep the inside of the air purifier dry. To prevent moisture buildup, avoid placing in rooms with major temperature changes or underneath air conditioners.
- **Always** unplug your air purifier before servicing (such as changing the filter).
- **Do not** use your air purifier if it is damaged or not working correctly, or if the cord or plug is damaged. **Do not** try to repair it yourself. Contact **Customer Support** (see page 15).
- **WARNING: Do not** use this air purifier with solid-state speed controls (such as a dimmer switch).
- Not for commercial use. Household use **only**.

## Plug & Cord

- Keep air purifier near the outlet it is plugged into.
- **Never** place the cord near any heat source.
- **Do not** cover the cord with a rug, carpet, or other covering. **Do not** place the cord under furniture or appliances.
- Keep the cord out of areas where people walk often. Place the cord where it will not be tripped over.

# READ AND SAVE THESE INSTRUCTIONS

# GETTING TO KNOW YOUR AIR PURIFIER

- A. Fan Speed Indicators
- B. Fan Speed Button
- C. Sleep Mode Indicator/Button
- D. Timer Button
- E. Timer Indicators
- F. On/Off Button
- G. Night Light Button
- H. Check Filter Indicator
- I. Display Off Button
- J. Air Outlet
- K. Housing
- L. Air Inlet
- M. Power Cord
- N. Filter Cover Cap
- O. Filter Cover Cap
- P. True HEPA Filter

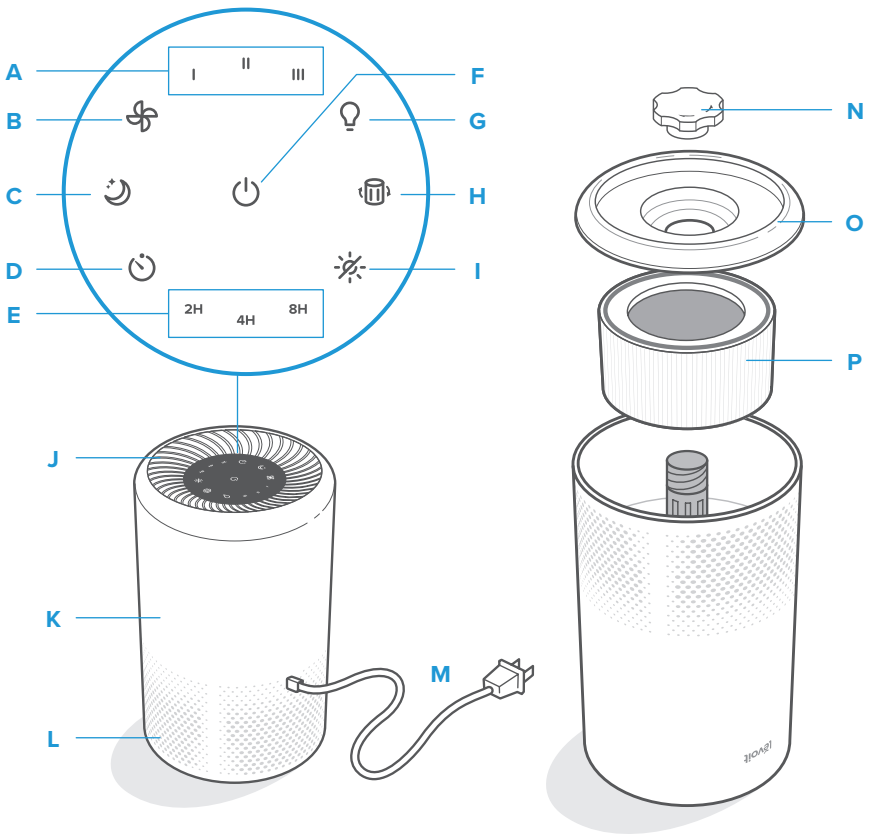

*Back*

*Front, upside down*

## CONTROLS



### On/Off Button

- Turns the air purifier on/off.



### Fan Speed Button

- Cycles through fan speeds: I (low), II (medium), and III (high).



### Sleep Mode Button

- Turns Sleep Mode on/off (see page 8).



### Timer Button

- Cycles through timer options (see page 8).



### Night Light Button

- Turns the night light on/off (see page 8).



### Check Filter Indicator

- Lights up when the filter should be checked (see [Check Filter Indicator](#), page 10).



### Display Off Button

- Turns the display off.
- Tap any button (except ) to turn the display back on.

## GETTING STARTED

1. Flip over the air purifier. Twist the filter cover cap counterclockwise to remove it and set it aside. [\[Figure 1.1\]](#)
2. Lift the filter cover off the purifier. [\[Figure 1.2\]](#)
3. Remove the filter from its plastic packaging and place the filter back into the purifier. [\[Figure 1.3\]](#)

**Note:** The filter does not have a top or bottom and can be installed either way.

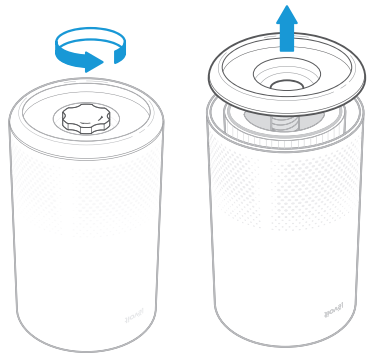

Figure 1.1

Figure 1.2

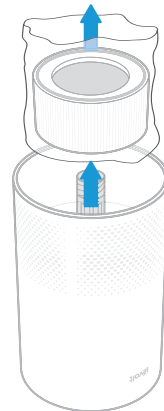

Figure 1.3

## GETTING STARTED (CONT.)

4. Replace the filter cover and the cap. Twist the cap clockwise to lock. *[Figure 1.4]*
5. Place the purifier on a flat, stable surface with the display facing up. Allow at least 15 in / 38 cm of clearance on all sides of the purifier. Keep away from anything that would block air flow, such as curtains. *[Figure 1.5]*

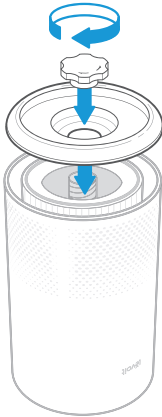

Figure 1.4

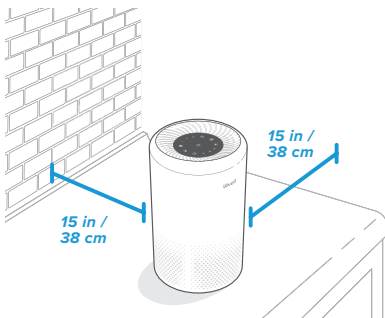





Figure 1.5

## USING YOUR PURIFIER

1. Plug in and tap  to turn on the air purifier. The fan will start on level I.
2. Optionally, tap  to change fan speed between I, II, and III.

### Note:

- The indicators are not buttons and cannot be used to change the fan speed.
  - The fan speed indicators will light up when activated.
  - Fan speed III is the loudest, but cleans air the quickest.
  - For best results, or to address a specific air quality issue such as smoke, run the air purifier at high speed (level III) for 15–20 minutes before using a lower speed.
  - To effectively clean air, keep windows and doors closed while the air purifier is on.
3. Tap  to turn off the air purifier.

### Memory Function

When the air purifier is plugged in, it will remember its previous fan speed setting.

## USING YOUR PURIFIER (CONT.)

### Sleep Mode

Sleep Mode operates quietly by using the lowest possible fan speed.

Tap  to turn Sleep Mode on/off.

#### Note:

- All indicators lower their brightness by  $\frac{1}{3}$  when Sleep Mode is on.
- Tapping  will exit Sleep Mode.

### Timer

You can set a timer for 2, 4, or 8 hours.

1. Tap  repeatedly to select a time.

#### Note:

- The indicators are not buttons and cannot be used to select a time.
- The timer indicators will light up blue when activated.

2. The air purifier will automatically power off once the timer is finished.

3. To cancel a timer, tap  until all timer indicators are off.

#### Note:

- You can change the fan speed at any time while the timer is on.
- The timer will restart if it is changed.

### Night Light

Use 1 of 2 brightness levels.

1. Tap once to turn on the light.

2. Tap a second time to dim the brightness to half.

3. Tap a third time to turn off the light.

#### Note:

- The night light can be used any time the air purifier is plugged in, even if it is not on.
- The night light will remain on, even if you turn the display off.

## ABOUT THE FILTER

The air purifier uses a 3-stage filtration system to purify air.

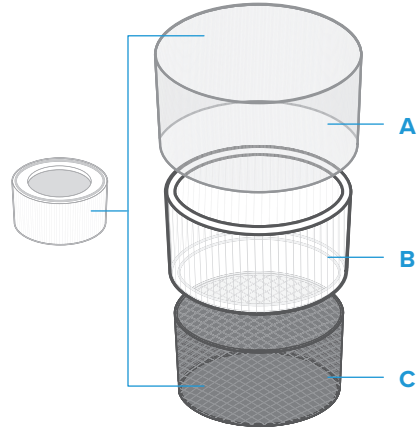

### A. Nylon Pre-Filter

- Captures large particles such as dust, lint, fibers, hair, and pet fur.
- Maximizes the filter's life.

### B. True HEPA Filter

- Removes at least 99.97% of airborne particles 0.3 micrometers ( $\mu\text{m}$ ) in diameter.
- Filters small particles such as smoke, tiny dust particles, mold spores, bacteria, viruses, and allergens such as pollen, dander, and mites.

### C. High-Efficiency Activated Carbon Filter

- Physically adsorbs unwanted odors and fumes.
- Filters compounds such as formaldehyde, benzene, ammonia, hydrogen sulfide, and volatile organic compounds (VOCs).



## ABOUT THE FILTER (CONT.)

### Humidity

Moisture may damage the filters. This air purifier should be used in an area with a humidity level below 85% RH. If you use the air purifier in excessively humid areas, the surface of the filter will become moldy.

**Note:** Water or moisture will allow mold to grow. Air purifiers cannot solve an existing mold problem, only remove mold spores and reduce odors.

### Essential Oils

**Do not** add essential oils to the air purifier or filter. The filter will become damaged by the oil and will eventually release an unpleasant smell. **Do not** use oil diffusers near the purifier.

# CARE & MAINTENANCE

## Cleaning the Air Purifier

- Unplug before cleaning.
- Wipe the outside of the air purifier with a soft, dry cloth. If necessary, wipe the housing with a damp cloth, then immediately dry.
- Vacuum the inside of the air purifier.
- **Do not** clean with abrasive chemicals or flammable cleaning agents.



## When Should I Replace the Filter?

The filter should be replaced every 6–8 months. You may need to replace your filter sooner or later depending on how often you use your air purifier. Using your air purifier in an environment with relatively high pollution may mean you will need to replace the filter more often, even if  is off.

You may need to replace your filter if you notice:

- Increased noise when the air purifier is on
- Decreased airflow
- Unusual odors
- A visibly clogged filter

### Note:

- If your home has high air pollution, you may need to change your filter before  lights up.
- Remember to reset  after changing the filter.

To maintain the performance of your air purifier, **only** use official Levoit filters. To buy replacement filters, scan the QR code or go to Amazon and search **B07PM9Q9GH (1 pack)** or **B07S2V987N (2 pack)**. You can check the official website, **levoit.com**, for more information.





**1 pack**  
B07PM9Q9GH



**2 pack**  
B07S2V987N

## Check Filter Indicator

 will light up as a reminder to check the filter. Depending on how much you use the air purifier, the indicator should turn on within 6–8 months. You may not need to replace your filter yet, but you should check it when  turns on.









## CARE & MAINTENANCE (CONT.)

### Cleaning the Filter

The True HEPA Filter should be cleaned once a month to increase the efficiency and extend the life of your filter. Clean the inside and outside of the filter using a soft brush or vacuum hose to remove hair, dust, and large particles. **Do not** clean the filter with water or other liquids.

### Resetting the Check Filter Indicator

Reset the Check Filter Indicator when:

- A.  lights up.
  - 1. Replace the filter.
  - 2. Turn on the air purifier.
  - 3. Press and hold  for 3 seconds.
  - 4.  will turn off when successfully reset.
- B. The filter was changed before  lit up.
  - 1. Press and hold  for 3 seconds. This will turn on .
  - 2. Press and hold  again for 3 seconds.
  - 3.  will turn off when successfully reset.

### Replacing the Filter

1. Unplug the air purifier. Flip the air purifier over and remove the filter cover cap and filter cover (see [Getting Started](#), page 6).
2. Remove the old filter.
3. Clean any remaining dust or hair inside the purifier using a vacuum hose. **Do not** use water or liquids to clean the purifier. [\[Figure 2.1\]](#)
4. Unwrap the new filter and place it into the housing (see [Getting Started](#), page 6).
5. Replace the cover and cap. Plug in the air purifier.
6. Reset the Check Filter Indicator.

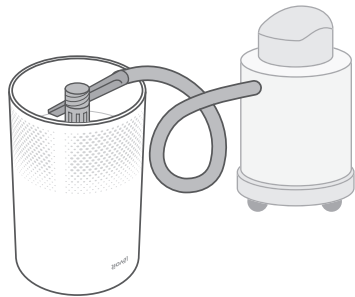



Figure 2.1







### Storage

If not using the air purifier for an extended period of time, wrap both the purifier and the filter in plastic packaging and store in a dry place to avoid moisture damage.

# TROUBLESHOOTING

Problem	Possible Solution
<p>Air purifier will not turn on or respond to button controls.</p>	<p>Plug in the air purifier.</p>
	<p>Check to see if the power cord is damaged. If so, stop using the air purifier and contact <b>Customer Support</b> (see page 15).</p>
	<p>Plug the air purifier into a different outlet.</p>
	<p>Air purifier is malfunctioning. Contact <b>Customer Support</b> (see page 15).</p>
<p>Airflow is significantly reduced.</p>	<p>Make sure the filter is removed from its packaging and properly in place (see page 6).</p>
	<p>Tap  to increase the fan speed.</p>
	<p>Make sure there are at least 15 in / 38 cm of clearance on all sides of the air purifier.</p>
	<p>Replace the filter (see page 11).</p>
<p>Air purifier makes an unusual noise while the fan is on.</p>	<p>Make sure the filter is properly in place with plastic packaging removed (see page 6).</p>
	<p>Make sure the air purifier is operating on a hard, flat, even surface.</p>
	<p>Replace the filter (see page 11).</p>
	<p>The air purifier may be damaged, or a foreign object may be inside. Stop using the air purifier and contact <b>Customer Support</b> (see page 15). <b>Do not</b> try to repair the air purifier.</p>
<p>Poor air purification quality.</p>	<p>Tap  to increase the fan speed.</p>
	<p>Make sure no objects are blocking the sides or top of the air purifier (the inlet or outlet).</p>
	<p>Make sure the filter is removed from its packaging and properly in place (see page 6).</p>
	<p>Close doors and windows while using the air purifier.</p>
	<p>Make sure the room is smaller than 172 ft<sup>2</sup> / 16 m<sup>2</sup>. The air purifier may not be as effective in larger rooms.</p>
	<p>Replace the filter (see page 11).</p>

## TROUBLESHOOTING (CONT.)

Problem	Possible Solution
Strange smell coming from the purifier.	Clean the filter or replace if necessary.
	Contact <b>Customer Support</b> (see page 15).
	Make sure not to use your purifier in an area with high humidity or while diffusing essential oils.
 is still on after replacing the filter.	Reset the Check Filter Indicator (see page 11).
 has not turned on within 8 months.	 is a reminder for you to check the filter and will light up based on how long the air purifier has been used (see page 10). If you don't use your air purifier often,  will take longer to turn on.
 turned on before 6 months.	 is a reminder for you to check the filter and will light up based on how long the air purifier has been used (see page 10). If you run your air purifier frequently,  will turn on sooner.
Air does not flow evenly out of the air purifier.	This is due to the design of the air purifier. This is normal and will not affect the air purifier's efficiency.

If your problem is not listed, please contact **Customer Support** (see page 15).

# WARRANTY INFORMATION

Product	True HEPA Air Purifier
Model	Vista 200
Default Warranty Period	1 year
<i>For your own reference, we strongly recommend that you record your order number and date of purchase.</i>	
Order ID	
Date of Purchase	

## Terms & Policy

Arovast Corporation warrants all products to be of the highest quality in material, craftsmanship, and service, effective from the date of purchase to the end of the warranty period.

Arovast Corporation will replace any product found to be defective due to manufacturer flaws based on eligibility. Refunds are available within the first 30 days of purchase. Refunds are only available to the original purchaser of the product. This warranty extends only to personal use and does not extend to any product that has been used for commercial, rental, or any other use for which the product is not intended. There are no warranties other than the warranties expressly set forth with each product.

This warranty is non-transferrable. Arovast Corporation is not responsible in any way for any damages, losses, or inconveniences caused by equipment failure or by user negligence, abuse, or use noncompliant with the user manual or any additional safety or use warnings included in the product packaging and manual.

### **This warranty does not apply to the following:**

- Damage due to abuse, accident, alteration, misuse, tampering, or vandalism.
- Improper or inadequate maintenance.
- Damage in return transit.
- Unsupervised use by children under 18 years of age.

Arovast Corporation and its subsidiaries assume no liability for damage caused by the use of the product other than for its intended use or as instructed in the user manual. Some states do not allow this exclusion or limitation of incidental or consequential losses so the foregoing disclaimer may not apply to you. This warranty gives you specific legal rights and you may also have other rights which may vary from state to state.

**ALL EXPRESSED AND IMPLIED WARRANTIES, INCLUDING THE WARRANTY OF MERCHANTABILITY, ARE LIMITED TO THE PERIOD OF THE LIMITED WARRANTY.**

## Extend Your Warranty by 1 Year

Register your product at [www.levoit.com/warranty](http://www.levoit.com/warranty) to extend your 1-year warranty by an additional year.

Please fill out all required fields and include your order ID, place of purchase, and purchase date, if applicable.

## Defective Products & Returns

If you discover your product is defective within the specified warranty period, please contact Customer Support via [support@levoit.com](mailto:support@levoit.com) with a copy of your invoice and order ID. **DO NOT** dispose of your product before contacting us. Once our Customer Support Team has approved your request, please return the product with a copy of the invoice and order ID.

# CUSTOMER SUPPORT

If you have any questions or concerns about your new product, please contact our helpful Customer Support Team.

**Arovast Corporation**

1202 N. Miller St., Suite A  
Anaheim, CA 92806

**Email:** [support@levoit.com](mailto:support@levoit.com)

**Toll-Free:** (888) 726-8520

## Support Hours

Mon–Fri, 9:00 am–5:00 pm PST/PDT

\*Please have your order invoice and order ID ready before contacting Customer Support.

# levoit

levoit.com

Connect with us @LevoitLifestyle

